

MEGA-FLASH

LED Warning Signals

MEGA-FLASH Lightbar - Datasheet



Low-Profile



Bullitt Basic



Spartan Basic



Double-Stack

Manufactured in the UK by **REDTRONIC**

Contents / Contenu / Inhalt / Contenido / Innehållsförteckning / Inhoud

	Unpacking	3
	Mounting	4
	Installation	4
	Cables	5
	Fuse	5
	Flash Pattern	6
	Sync	6
	Cleaning	9
	Temporary Mounts	9
	Conditions of Use	10
	Warranty	11
	12
	Déballage	3
	Montage	4
	Installation	4
	Cables	5
	Fusible	5
	Clignotement	6
	Sync	6
	Nettoyage	9
	Éléments de fixation temporaires	9
	Conditions d'utilisation	10
	Garantie	11
	12
	Auspacken	3
	Montage	4
	Installation	4
	Kabel	5
	Sicherung	5
	Blinklicht Muster	6
	Sync	6
	Reinigen	9
	Abnehmbare Montage	9
	Nutzungsbedingungen	10
	Garantie	11
	12
	Desembalaje	3
	Montaje	4
	Instalación	4
	Cables	5
	Fusible	5
	Sistema Flash	6
	Sync	6
	Limpieza	9
	Montaje temporal	9
	Condiciones de uso	10
	Garantía	11
	12
	Uppackning	3
	Montering	4
	Installation	4
	Kablar	5
	Säkring	5
	Blixtmönster	6
	Synkronisering	6
	Rengöring	9
	Tillfälliga monteringar	9
	Användarvillkor	10
	Garanti	11
	12
	Uitpakken	3
	Montage	4
	Installatie	4
	Kabels	5
	Zekering	5
	Flitspatroon	6
	Synchronisatie	6
	Reinigen	9
	Tijdelijke bevestiging	9
	Gebruiksvoorwaarden	10
	Garantie	11
	12

Unpacking / Déballage / Auspacken / Desembalaje / Uppackning / Uitpakken



1) Check the box for damage in transit. If the box is damaged inform your designated sales representative immediately. (If the consignment is not signed for as 'damaged' it may affect whether the product can be repaired or replaced free of charge)

2) Carefully remove the lightbar from the box and place it on a flat and stable surface, taking extra care not to scratch the lenses.

3) Examine the lightbar for damage such as cracked or scratched lenses. Report any damage to your designated sales representative.



1) Retirer délicatement la rampe lumineuse de la boîte et la placer sur une surface plane et stable, en prenant soin de ne pas rayer les cabochons. (Si la consignment n'est pas marquée comme « endommagée », cela peut affecter la procédure de réparation ou de remplacement gratuit)

2) Retirer délicatement la barre lumineuse de la boîte et le placer sur une surface plane et stable, en prenant soin de ne pas rayer les verres.

3) Examiner la barre lumineuse pour les dommages tels que des lentilles fendues ou rayées. Signalez tout dommage à votre représentant commercial désigné.



1) Prüfen Sie die Verpackung auf Transportschäden. Wenn die Verpackung beschädigt ist, benachrichtigen Sie bitte sofort ihren Händler. (Wenn die Warenlieferung nicht als "Beschädigt" gekennzeichnet wird, kann eine kostenfreie Reparatur oder Ersatz ausgeschlossen sein)

2) Packen Sie den Leuchtbalken vorsichtig aus und stellen Sie ihn auf eine stabile Unterlage und achten Sie besonders darauf, dass das Glas nicht zerkratzt wird.

3) Prüfen Sie den Leuchtbalken auf Schäden, wie gesprungenes oder zerkratztes Glas. Melden Sie jeden Schaden Ihrem Händler.



1) Mirar si la caja fue dañada en el transporte. Si la caja esta dañada, inmediatamente informe a su comercial respectivo. (Si la remesa no se firma como "dañada" eso puede afectar si el producto puede ser reparado o reemplazado gratuitamente en garantía.)

2) Retire con cuidado la barra de luz de la caja y colóquela sobre una superficie plana y estable, teniendo mucho cuidado de no rayar las lentes.

3) Compruebe si la barra de luz si esta rota o si las lentes están rayadas. Notifique cualquier defecto a su respectivo comercial.



1) Kontrollera om transportskador finns på emballaget och anmäl detta direkt till speditören. (Om produkten eller emballaget mottages i skadat skick och detta inte anmäls till speditören kan det leda till att produkten inte repareras eller byts ut kostnadsfritt).

2) Ta fram ljuskrampen försiktigt ur lådan och placera den på en plan och stabil yta och var extra noggrann för att inte repa linserna.

3) Kontrollera ljusrampen för skador som spruckna eller repade lins. Rapportera eventuella skador till din utsedda försäljare.



1) Controleer de doos op beschadigingen tijdens het vervoer. Als de doos beschadigd is, stel hiervan dan onmiddellijk uw leverancier in kennis. (Als de zending door ondertekening als niet 'beschadigd' wordt bevestigd, kan dit van invloed zijn op de mogelijkheid tot reparatie of vervanging van het product.)

2) Haal de lichtbalk voorzichtig uit de doos en leg deze op een vlakke en stabiele ondergrond. Zorg hierbij dat de lenzen niet bekrast raken.

3) Controleer de lichtbalk op beschadigingen, zoals gebarsten of bekraste lenzen. Meld alle beschadigingen bij uw leverancier.

Mounting / Montage / Montage / Montaje / Montering / Montage



Mega-Flash lightbars are available with a variety of fixing methods. If the lightbar has a different fixing method other than the standard universal footpck (shown below) please contact your sales representative for further assistance. All parts are stainless steel.



Les rampes lumineuses Mega-Flash sont disponibles avec une variété de méthodes de fixation. Si la barre lumineuse se fixe de manière différente autre qu'avec le kit de montage pour les coffres de voitures universel (ci-dessous) contacter votre représentant commercial pour obtenir l'assistance. Toutes les pièces sont en acier inoxydable.



Die Mega-Flash Leuchtbalken sind mit einer Reihe von Befestigungsmethoden lieferbar. Wenn der Leuchtbalken über eine andere Befestigungsart als die universellen Standardfüße verfügt (wie unten abgebildet), bitten Sie Ihren Händler um Hilfe. Alle Teile aus rostfreiem Stahl.



Las barras de luz Mega-Flash son disponibles con una variedad de métodos de fijación. Si la barra de luces tiene un método de fijación diferente a la del estándar y universal (se muestra abajo), por favor póngase en contacto con su comercial para obtener más ayuda. Todas las piezas están hechas de acero inoxidable.



Fleråtalet olika fästen finns tillgängliga till MEGA-FLASH ljusramperna. Om annan fästmåttningmetod än standard monteringskit används (se nedan) vänligen kontakta ansvarig säljare. Samtliga monteringsdetaljer är i rostfritt stål.



Mega-Flash daksets zijn verkrijgbaar met een verscheidenheid aan bevestigingsmethoden. Als de dakset een bevestigingsmethode heeft die verschilt van de standaard universele voetset (zoals hieronder afgebeeld), neem dan contact op met uw leverancier voor verdere assistentie. Alle onderdelen zijn van roestvrij staal.

REF#	Qty	Description	Torque
A	8x	M8 Nyloc Nut	4 N.m
B	12x	M8 X 21 Ring Washer	N/A
C	8x	M6 X 20 Ring Washer	N/A
D	8x	M8 X 25 Coach Bolt	N/A
E	4x	M8 X 25 Allen Socket Screw	4 N.m
F	4x	M6 X 25 Set Screw	N/A
G	4x	M6 Nyloc Nut	4 N.m
H	4x	M8 Square Nut	N/A
I	4x	Rubber Foot	N/A
J	1x	5mm Allen Key	N/A
K	1x	Rubber Spacer/Pad	N/A

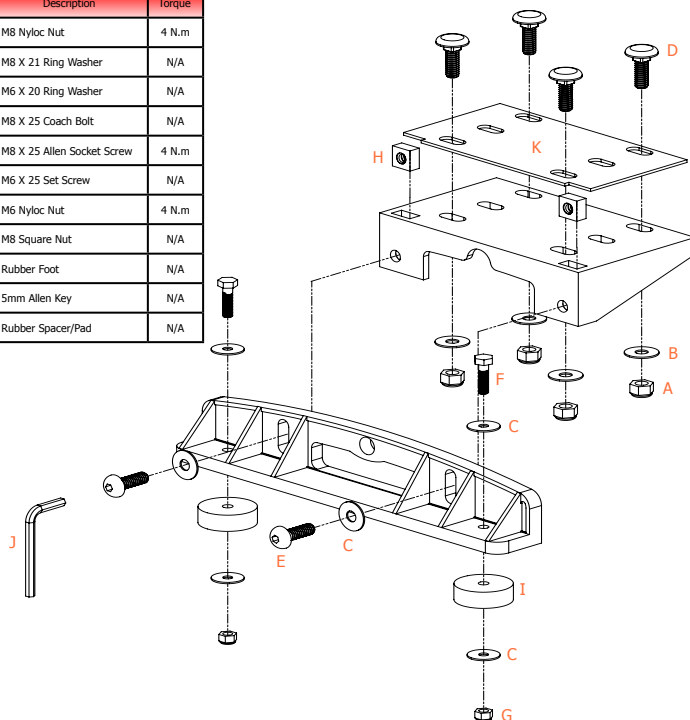

Installation / Installation / Installation / Instalación / Installation / Installatie



Quick-test procedure only applies to standard hardwired lightbars. If the lightbar is not a standard build product please refer to 'Cables' on page 6.



La procédure du test rapide s'applique uniquement aux rampes lumineuses standards câblées. Si la rampe lumineuse n'est pas standard, alors se référer à la page 6 pour le schéma de câblage.



Die Schnelltest Prozedur kann nur bei standardmäßig verkabelten Leuchtbalken durchgeführt werden. Falls es sich bei dem Leuchtbalken nicht um einen Standard Leuchtbalken handelt, schlagen Sie bitte unter "Kabel" auf Seite 6 nach.



Procedimiento de prueba rápida se aplica solamente a las barras de luces estándares con cableado. Si la barra de luz no es un producto aprovisionado en la versión estándar, mire la parte de "Cables" en la página 6.



Snabbtest gäller endast för standard bestyckade ljusrampor. För specialbestyckade ljusrampor utöver standardutförande se sidan 6 "Kablar".



De sneltest-procedure alleen uitvoeren bij daksets met standaard kabelboom. Als de dakset geen standaard uitvoering is, raadpleeg dan de sectie 'Kabels' op pagina 6.

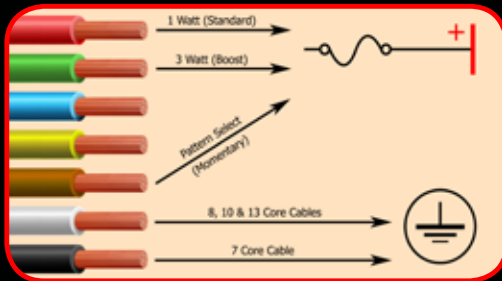

Pattern Select - Momentary

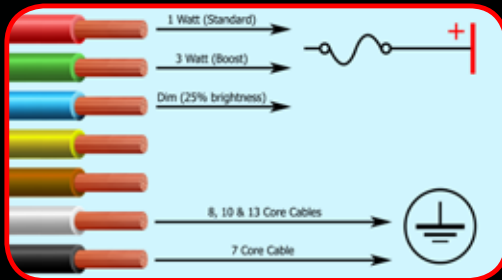

Dim - Reduces to 25% brightness

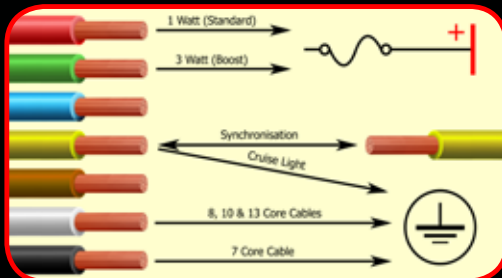

Synchronisation to MF products



Synchronisation avec des produits MF



Synchronisation mit MF-Produkten



Sincronización con los productos MF



Synkronisering mellan MF produkter









Synchronisatie met MF-producten

Cables / Câbles / Kabel / Cables / Kablar / Kabels

4 Core ● 6 Core ● 7 Core ● 8 Core ● 10 Core ● 13 Core ●

	Red	Blue	Yellow	Brown	Green	Orange	Purple	Grey	Pink	White	Black
1) Blue Lights											
2) Amber Lights											
3) Red Lights											
4) Green Lights											
5) White Lights											
6) Magenta Lights											
7) Pattern Select				+ve							
8) Dim Mode		+ve									
9) Boost Power					+ve						
10) Synchronisation			✓								
11) Front Takedown											
12) Front Floods											
13) Rear Worklamps											
14) Rear Reds											
15) Alley Left											
16) Alley Right											
17) Stop Lights											
18) Tail Lights											
19) Indicator Left											
20) Indicator Right											
21) Split Front											
22) Split Rear											
23) Centre Sign											
24) Siren Standby											
25) +ve Siren Trip											
26) -ve Siren Trip											
27) Speaker Cable 1											
28) Speaker Cable 2											
29) Siren Comp Output											
30) Tone 1											
31) Tone 2											
32) Tone 3											
33) Siren Test Mode											
34) -ve Earth											
35) -ve Earth 2											

MEGA-FLASH Lightbar - Datasheet

					
1) Blue Lights	Feux bleus	Blaulichter	Luces azules	Blått ljus	Blauwe LED's
2) Amber Lights	Feux jaunes	Gelblichter	Luces amarillas	Gult ljus	Oranje LED's
3) Red Lights	Feux rouges	Rotlichter	Luces rojas	Rött ljus	Rode LED's
4) Green Lights	Feux verts	Grünlichter	Luces verdes	Grönt ljus	Groene LED's
5) White Lights	Feux blancs	Weißlichter	Luces blancas	Vitt ljus	Witte LED's
6) Magenta Lights	Feux magenta	Violette Leuchten	Luces Magenta	Magenta ljus	Roze LED's
7) Pattern Select	Sélection du mode de fonctionnement	Auswahl der Betriebsart	Elección de modo de trabajo	Blinkmönster	Patroon selecteren
8) Dim Mode	Mode nuit	Nachtmodus	Modo nocturno	Dim läge	Dimmodus
9) Boost Power	Alimentation supplémentaire	Leistungserhöhung	Aumentar potencia	Boost läge	Boost (verhoging) vermogen
10) Synchronisation	Synchronisation	Synchronisierung	Sincronizar	Synkronisering	Synchronisatie
11) Front Takedown	Feux d'alarme avant	Vordere Interventionsleuchten	Focos delanteros de intervención	Takedown fram	Takedown voorkant
12) Front Floods	Feux avant	Vordere Scheinwerfer	Focos delanteros	Arbetsljus fram	Schijnwerper voorkant
13) Rear Worklamps	Feux de fonctionnement arrière	Hintere Betriebslichter	Luces traseras de trabajo	Arbetsljus bak	Werklampen achterkant
14) Rear Reds	Feux rouges arrière	Hintere Rotleuchten	Luces traseras rojas	Positionsljus bak	Rode lichten achterkant
15) Alley Left	Feux directionnels gauches	Linke Richtlampe	Luz izquierda de dirección	Sidoljus vänster	Alleylights links
16) Alley Right	Feux directionnels droits	Rechte Richtlampe	Luz derecha de dirección	Sidoljus höger	Alleylights rechts
17) Stop Lights	Feux de Stop	Standlichter	Luces de parar	Bromsljus bak	Remlichten
18) Tail Lights	Feux arrière	Schlussleuchten	Luces traseras	Varselljus	Achterlichten
19) Indicator Left	Clignotant gauche	Linke Blinkleuchte	Intermitente izquierdo	Blinkers vänster	Linker knipperlichten
20) Indicator Right	Clignotant droit	Rechte Blinkleuchte	Intermitente derecho	Blinkers höger	Rechter knipperlichten
21) Split Front	Feux frontal indépendant	Getrennte Vorderleuchte	Luz delantera separada	Split fram	Voorzijde apart in-/uitschakelbaar
22) Split Rear	Feux auxiliaire arrière	Separates Schlusslicht	Luz trasera separada	Split bak	Achterzijde apart in-/uitschakelbaar
23) Centre Sign	Cache central	Mittlere Markierung	Señal del medio	Reklamplats	Verlicht middenstuk
24) Siren Standby	"+" permanent sirène	Sirene-Notversorgung	Sirena-Suministro de energia de emergencia	Standby för siren	Stand-by voor sirene
25) +ve Siren Trip	Câble interrupteur de la sirène (pôle positif)	Sellausschalter der Sirene (positiver Pol)	+ Ve cable de trampa de sirena	+ve siren trip	Sirene activering (positieve pool)
26) -ve Siren Trip	Massa commutateur de sirène	Sirenenumschalter (negativer Pol)	Commutador de sirena (polo negativo)	-ve siren trigger	Sirene activering (negatieve pool)
27) Speaker Cable 1	Câble du haut-parleur 1	1. Lautsprecherleitung	1. Cable de altavoz	Högtalarkabel 1	Luidsprekerkabel 1
28) Speaker Cable 2	Câble du haut-parleur 2	2. Lautsprecherleitung	2. Cable de altavoz	Högtalarkabel 2	Luidsprekerkabel 2
29) Siren Comp Output	Sortie ordinateurur de sirène	Ausgang des Sirenen-Computers	Salida de ordenador de sirena	Siren signal ut	Uitgang sirene-computer
30) Tone 1	Tonalité 1	Ton 1	Tono 1	Ton 1	Toon 1
31) Tone 2	Tonalité 2	Ton 2	Tono 2	Ton 2	Toon 2
32) Tone 3	Tonalité 3	Ton 3	Tono 3	Ton 3	Toon 3
33) Siren Test Mode	Mode de test de la sirène	Sirene-Testmodus	Modo de prueba de sirena	Siren test	Testmodus sirene
34) -ve Earth	Mise à la terre (négatif)	Erdung (negativer Pol)	Toma de tierra (NEGATIVA)	-ve jord	Aarde (negatieve pool)
35) -ve Earth 2	Mise à la terre 2 (négatif)	2. Erdung(negativer Pol)	2. Toma de tierra (NEGATIVA)	-ve jord 2	Aarde (negatieve pool) 2

Fuse / Fusible / Sicherung / Fusible / Säkring / Zekering



The following table can be used as a guide to determine the maximum current from standard builds: (24v vehicles will draw approximately half the current shown in the table below. Installers should contact their sales representative if they are unfamiliar with fusing requirements)



Le tableau suivant peut être utilisé comme un guide pour déterminer l'intensité maximale de courant à partir de versions standards: (véhicules à 24v consomment environ la moitié du courant indiqué dans le tableau ci-dessous. Les installateurs doivent contacter leurs représentants commerciaux s'ils ne sont pas familiers avec les exigences des fusibles).



Die folgende Tabelle kann als Hinweis für die Bestimmung der maximalen Stromaufnahme bei Standardausführung verwendet werden: (24V Fahrzeuge benötigen ungefähr die Hälfte des in der Tabelle aufgeführten Stroms) Wenn die Anforderungen an die Sicherungen nicht eindeutig klar sind, wenden Sie sich bitte an Ihren Händler)



Se puede utilizar la siguiente tabla como una guía para determinar el corriente máximo de construcciones estándares: (los vehículos 24v van a consumir la mitad de la corriente mostrada en la tabla de abajo. Los instaladores deben contactar a su comercial si no están familiarizados con los requerimientos de fusibles)



Nedan tabell kan användas för uträkning av strömförbrukning för standard bestyckade produkter. (24V fordon kommer dra cirka hälften av angiven strömförbrukning som visas i tabellen nedan. Installatörer bör kontakta ansvarig säljare vid oklarheter gällande avsäkring etc).



De volgende tabel kan worden gebruikt om het maximale stroomverbruik van de standaard daksets te bepalen (bij 24 volt voertuigen zal ongeveer de helft van de stroom verbruikt worden. Installateurs dienen hun leverancier te raadplegen als ze de eisen met betrekking tot zekeringen niet kennen).

Lightbar Size	Lightbar Style	Number of Controllers	Number of LEDs	Flash Pattern	1 Watt Max Current 12v	3 Watt Max Current 12v	Dim mode Max Current 12v (25% brightness)
All sizes	ECO (Low-Profile)	2	48	Mega-Flash, Single, Hyper	2 Amps	4 Amps	500 mAmps
				Quad, Triple, Double	1.3 Amps	2.6 Amps	325 mAmps
All sizes	3000 (Low-Profile)	3	72	Mega-Flash, Single, Hyper	3 Amps	6 Amps	750 mAmps
				Quad, Triple, Double	2 Amps	4 Amps	500 mAmps
30cm - 120cm	FX1 (Low-Profile)	1	24	Mega-Flash, Single, Hyper	1.6 Amps	3.2 mAmps	200 mAmps
				Quad, Triple, Double	1.1 Amps	2.2 mAmps	100 mAmps
All sizes	FX1 (Double-Stack)	2	48	Mega-Flash, Single, Hyper	2 Amps	4 Amps	500 mAmps
				Quad, Triple, Double	1.3 Amps	2.6 Amps	325 mAmps

Flash Pattern / Clignotement / Signallichtmuster / Sistema Flash / Blinkmönster / Flitspatroon

Flash Pattern	ECE R65	1 Watt	3 Watt	Flashes (PM)
1) Mega-Flash	*	✓	✓	732
2) Quad	*	✓	✓	488
3) Triple	*	✓	✓	366
4) Double	✓	TB1 / TA1	TB2	244
5) Single	*	✓	✓	122
6) Hyper	*	*	✓	480



To reset all controllers to flash pattern 1, hold brown cable to positive for 2 seconds.



Pour réinitialiser tous les contrôleurs et le mettre en mode de clignotement 1: maintenir le câble marron au pôle positif pendant 2 secondes.



Um die Steuerung wieder auf das Signalmuster 1 zurückzusetzen, das braune Kabel für 2 Sekunden mit dem Pluspol verbinden.



Para restablecer todos los controladores del modelo flash 1, presione el cable marrón hacia el positivo durante 2 segundos.



För att återställa ljusrampen till blinkmönster 1 anslut den bruna kabeln till lämplig plusmatning i cirka 2sek.



De dakset terugzetten op flitspatroon 1 kan door de bruine kabel 2 seconden op de positieve pool te houden.

Sync / Sync / Sync / Sinc / Synkronisering / Synchronisatie



Most Mega-Flash products have been pre-programmed to include a synchronised flash rate. Products can be synchronised by connecting their yellow cables. All LEDs can be permanently illuminated (cruise light) by connecting the yellow cable to negative (Boost / 3 watt mode only).



La plupart des produits Mega-Flash ont été préprogrammés pour inclure une vitesse de clignotement synchronisée. Les produits peuvent être synchronisés en reliant leurs câbles jaunes. Tous les voyants peuvent être allumés en mode fixe (lumière de croisière) en connectant le câble jaune à la masse.



Die meisten Mega-Flash Produkte wurden auf eine synchronisierte Blitzrate vorprogrammiert. Produkte können durch Verbinden der gelben Kabel miteinander synchronisiert werden. Alle LEDs können ständig eingeschaltet werden, indem die gelben Kabel an den Minuspol angeschlossen werden (Boost / nur 3 Watt Betrieb).



La mayoría de los productos Mega-Flash están pre programados para inducir la velocidad de destellos. Los productos se pueden sincronizar conectando los cables amarillos. Todas las LED pueden estar permanentemente iluminadas (luces de viaje) conectando el cable amarillo al negativo (Elevación / solamente el modo de 3 vatios).



De flesta MEGA-FLASH ramperna med standard bestyckning är förprogrammerade att vara synkroniserade. Övriga produkter kan synkroniseras med hjälp av den gula anslutningskabeln. Samtliga led moduler kan ställas in i belysningsläge (cruise light) genom att ansluta den gula kabeln till jord (gäller endast i Boost / 3W läge).



De meeste Mega-Flash producten kunnen met andere Mega-Flash producten gesynchrooniseerd worden. Dit kan door onderling hun gele kabels met elkaar te verbinden. Het is mogelijk om alle LED's permanent zwak te laten branden (cruise light) door de gele kabel met de negatieve te verbinden (Boost / alleen in de 3-watt modus).

Cleaning / Nettoyage / Reinigung / Limpieza / Rengöring / Reinigen



No car washes / Pas de lave-auto / Keine Autowaschanlagen / No lavados de coches / Ingen biltvätt / Geen wasstraat



No jet washes / Pas de lavage à jet d'eau / Keine Hochdruckspritzen / No lavados a chorros / Ingen högtryckstvätt / Geen waterstralen



No brush washes / Pas de lavage à brosse / Keine Bürsten / No lavados con cepillo / Ingen borsttvätt / Geen schoonmaken met borstel



Microfibre cloths / Chiffons en microfibres / Mikrofiber Tücher / Trapos de microfibra / Microfiber dukar / Microvezeldoeken

Temporary Mounts / Eléments de fixation temporaires / Abnehmbare Montage / Montaje temporal / Tillfälliga monteringar / Tijdelijke bevestiging



It is highly recommended that all temporary mounted lightbars utilise the use of a safety lanyard as a secondary backup. Safety lanyards are available from your designated sales representative.



Il est fortement recommandé que toutes les rampes lumineuses montées temporairement utilisent un cordon de sécurité comme une sécurité complémentaire. Les cordons de sécurité sont disponibles auprès de votre représentant commercial désigné.



Es wird unbedingt empfohlen, dass abnehmbar befestigte Leuchtbalken mit einem Sicherheitsband abgesichert werden. Sicherheitsbänder erhalten Sie bei Ihrem Händler.



Es altamente recomendable que todas las barras de luces montadas temporalmente usen un acollador de seguridad como una seguridad secundaria. Acollador de seguridad se pueden obtener de los designados comerciales.



Det är starkt rekommenderat att alla tillfälligt monterade ljusrampor nyttjar säkerhetsband som en sekundär förankring. Säkerhetsband är tillgängliga via din lokala återförsäljare.



Het wordt sterk aanbevolen bij alle tijdelijk bevestigde daksets een veiligheidslijn als tweede back-up te gebruiken. Veiligheidslijnen zijn verkrijgbaar bij uw leverancier.



SUPER STRONG MAGNET



Contact the manufacturer direct for the maximum speed rating of temporary mounted products. If applicable, request a speed test certificate. Do not use a temporary mounted products without knowing their speed restrictions.



Contactez le fabricant directement pour la vitesse maximale des produits montés temporairement. Le cas échéant, demander un certificat du test de vitesse. Ne pas utiliser un produit monté temporairement sans connaître leurs limitations de vitesse.



Fragen Sie den Hersteller nach den maximalen Geschwindigkeiten bei abnehmbar montierten Produkten. Falls zutreffend, fragen Sie nach einem Geschwindigkeitstest Zertifikat. Verwenden Sie abnehmbar befestigte Produkte niemals ohne Kenntnisse über die Geschwindigkeitsbeschränkungen.



Póngase directamente en contacto con el fabricante para la clasificación de la velocidad máxima de los productos temporalmente montados. Si necesario, solicite un certificado de prueba de velocidad. No utilice los productos montados temporalmente sin conocer sus restricciones referentes a la velocidad.



Kontakta återförsäljaren direkt för den maximala hastigheten för tillfälligt monterade produkter. Om det är nödvändigt kan ett intyg för hastighetstest begäras. Använd inte en tillfälligt monterad produkt utan vetskap om maximalt tillåtna hastighet.



Raadpleeg uw leverancier voor de maximale snelheden van producten met tijdelijk bevestiging. Vraag, indien van toepassing, om een snelheidstestcertificaat. Gebruik geen producten voor tijdelijke bevestiging zonder hun snelheidslimiet te kennen.



SUCTION CUP

Conditions of Use / Conditions d'utilisation / Nutzungsbedingungen / Condiciones de uso / Användnings villkor / Gebruiksvoorwaarden



The following 'Warning Regarding Operation' section is only available in English. If you do not understand the following please do not use the Megafash lightbar without seeking help and guidance as to use of the same from your supplier. Use of the Megafash is entirely at your own risk.



L'« Avertissement concernant l'opération » suivant est disponible uniquement en anglais. Si vous ne comprenez pas le contenu suivant, n'utilisez pas la barre lumineuse Mega-Flash sans chercher l'aide et le conseil quant à l'utilisation de la même auprès de votre fournisseur. L'utilisation de Mega-Flash s'effectue entièrement à vos risques.



Der folgende Abschnitt 'Warning Regarding Operation.' ist nur auf Englisch verfügbar. Wenn Sie die folgenden Informationen nicht verstehen, verwenden Sie die Megafash Leuchtbalken nicht, ohne Anleitung und Hilfe von Ihrem Händler erhalten zu haben. Die Verwendung von Megafash erfolgt ausschließlich auf Ihr eigenes Risiko.



La siguiente sección de "Advertencias Referentes a la Operación" esta disponible solamente en ingles. Si no las entiende, por favor no utilice la barra de luces Megafash sin buscar ayuda y orientación sobre el uso de la misma a su proveedor. El uso del Megafash bajo su propio riesgo.



Följande avsnitt "Varning gällande driften" (Warnings Regarding Operation) är endast tillgänglig på engelska. Om du inte förstår nedan avsnitt fullt ut skall du kontakta återförsäljaren för vidare information gällande MEGA-FLASH produkterna. Användning av produkten sker på egen risk.



De volgende sectie "Waarschuwing met betrekking tot het gebruik" is alleen beschikbaar in het Engels. Als u de onderstaande tekst niet begrijpt, gebruik dan de Megafash dakset niet zonder uw leverancier te raadplegen voor hulp en advies met betrekking tot het gebruik ervan. Het gebruik van de Megafash dakset is geheel voor eigen risico.

1. The Mega-flash 360 low-profile & double-stack Lightbar ("Product") must only be fitted to a vehicle and used in accordance with this data sheet or any other terms and conditions of use as may appear upon Redtronic Limited's ("Supplier") website www.redtronic.co.uk.
2. The use of the Product does not ensure that other road users will observe or react to the emergency warning signal given by the Product. Users of the Product should not take any right of way upon the roads for granted. It is the user's responsibility to ensure that the user can proceed safely whilst driving and using the Product.
3. The safety and the effectiveness of the Product is dependent upon correct mounting and wiring. It is the user's obligation to ensure that the user follows these instructions within this data sheet when either installing and/or using the Product. Please ensure that the projection of the Product is not blocked by other components on the vehicle, or any other form of obstruction.
4. The Product is entitled for use by authorised personnel only who are legally permitted to use the Product as a warning device. It is the user's sole responsibility to understand and obey all laws regarding the use of such emergency warning devices.
5. The Product should be installed in such a manner so as to not reduce the output performance of the Product, and all controls in relation to the use of the Product should be placed within the convenient reach of the driver/operator so that he/she can operate the Product safely and so as to continue to drive in a safe manner.
6. The Product requires high electrical voltages and/or currents. The user should properly protect and use caution around live electrical connections, both by the user and by any third party. Grounding or shorting of electrical connections can cause high current arcing, which could cause personal injury and/or severe vehicle damage.
7. All users of the Product should ensure that they have been appropriately trained both in relation to the use of the Product and in relation to the use of emergency warning devices.
8. It is the user's responsibility at all times to ensure that the Product is used in a safe manner and in accordance with this data sheet.
9. The user should ensure that the Product is properly secured in line with this data sheet, and that the user takes into account variations in the weather and environmental conditions.
10. The Product should be tested and checked on a regular basis both before use and during use. The Product should not be used if it appears to be defective and/or to have malfunctioned.
11. The Supplier's warranties and liabilities are fully detailed in the Supplier's terms and conditions in relation to sale of the Product and use of the Product by its customers (as therein defined). In relation to use of the Product by any third party, the Supplier shall not be liable to such third party whether in contract, tort (including negligence), breach of statutory duty or otherwise (save for death or personal injury caused by the Supplier's negligence).

Warranty / Garantie / Garantie / Garantía / Garanti / Garantie

1. Warranty

1.1 From the date of their production or the internal allocation of any warranty number (whichever the later), the Supplier warrants to the Customer that the Products shall that period of time (either 2 years or 5 years) specified in the Suppliers Products brochure (in publication at the date of the Contract) comply with any stated specification and be free from defects in materials and workmanship.

2. Notification

2.1 Where the Customer believes the Products have been supplied in breach of the warranty detailed in condition 1, the Customer shall at its own expense, be required to return the Products to the Supplier for inspection.

2.2 The Supplier agrees to inspect the Products at an agreed location, subject to the Customer agreeing to pay the Supplier for such inspection services on a time and materials basis, which costs shall be communicated to and agreed with the Customer in advance of them being incurred.

2.3 The Customer shall on request, supply any warranty or manufacturing code which accompanies the Products.

3. Repair or Replacement

3.1 Following the inspection referred to in condition 2, subject to condition 4, the Supplier undertakes, at its option, to either repair or replace any Products which are found to be in breach of the warranty in condition 1 and to return such Products at its own expense to the Customer.

3.2 Following any repair or replacement, the warranty referred to in condition 1 shall continue for the unexpired portion of the relevant warranty period.

3.3 If the Products are reasonably considered by the Supplier not to be in breach of the warranty in condition 1, or if condition 4 applies, the Products shall only be returned to the Customer at the cost of the Customer, which costs must be paid in advance.

4. Exclusions

4.1 No warranty claim shall be entertained or dealt with by the Supplier if:

(a) the associated warranty or manufacturing code which accompanies the Products, is not supplied at the time of any notification pursuant to condition 2;

(b) the Customer waits longer than fourteen (14) days after becoming aware of the defect;

(c) the Customer continues to makes use of the Products in respect of which it gave notification;

(d) the Customer alters or repairs the relevant Products without the Suppliers prior written approval;

(e) the defect arises because the Customer failed to follow the Supplier's oral or written instructions as to the storage, installation, commissioning, use or maintenance of the Products or (if there are none) good trade practice;

(f) the defect arises because of the oxidisation of screws, bolts and fixings;

(g) the defect arises because of the use of lamp or other electrical equipment of a voltage which is higher than that recommended by the Supplier.